

American Polysteel PS 3890-L Scale 1.5"=12.0"

PLAN LEFT-HAND CORNER

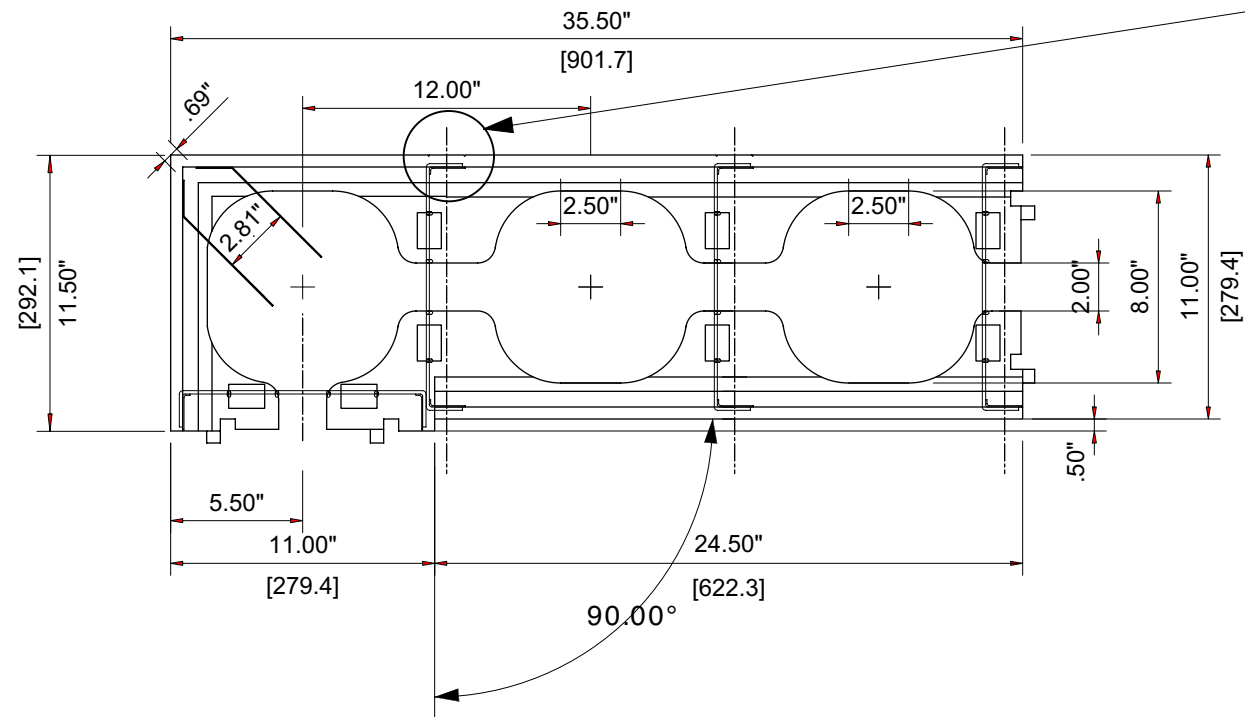

FRONT ELEV,

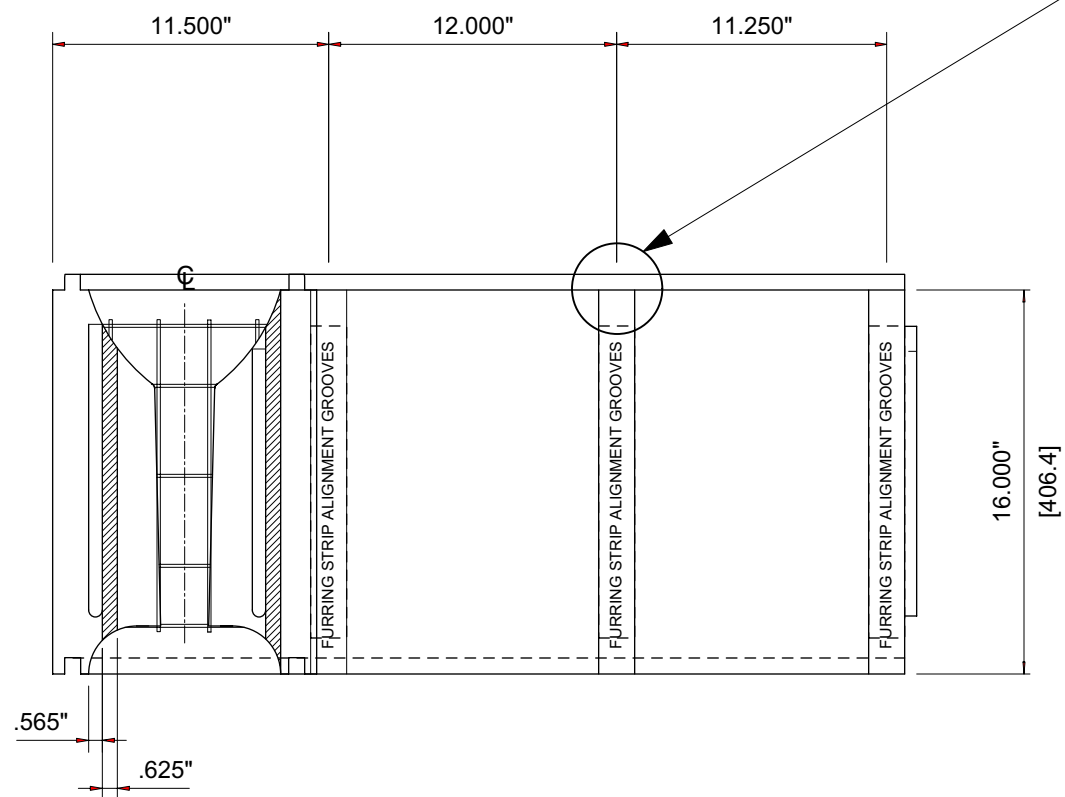

END ELEV,

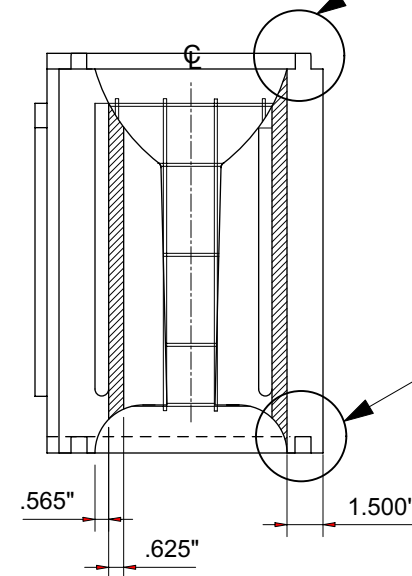

FURRING STRIP ALIGNMENT GROOVES
DEFINE ALL FURRING STRIPS
.062" DEEP x .062" WIDE

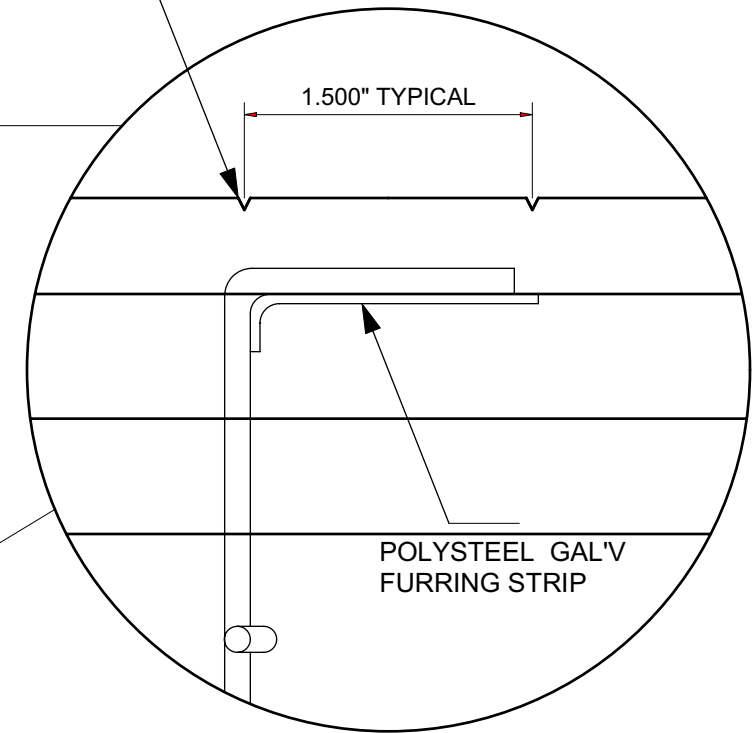

GROOVE DETAIL

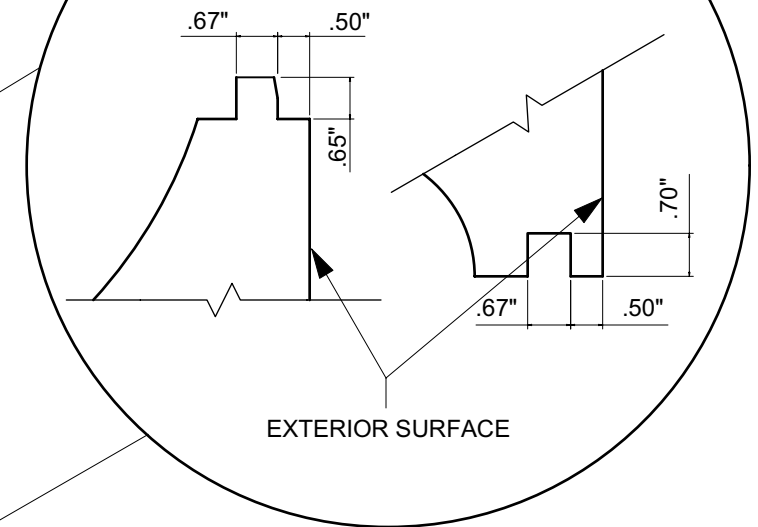

American Polysteel PS 3890-L

SCALE: 1.5"=12.0"	APPROVED BY:	DRAWN BY: AMH
DATE: Dec 2002		REVISED:
Copyright 2002		DRAWING NUMBER:
American Polysteel 1-800-977-3676		PS 3890-L